 $D \times 24 = M4 \times 45$

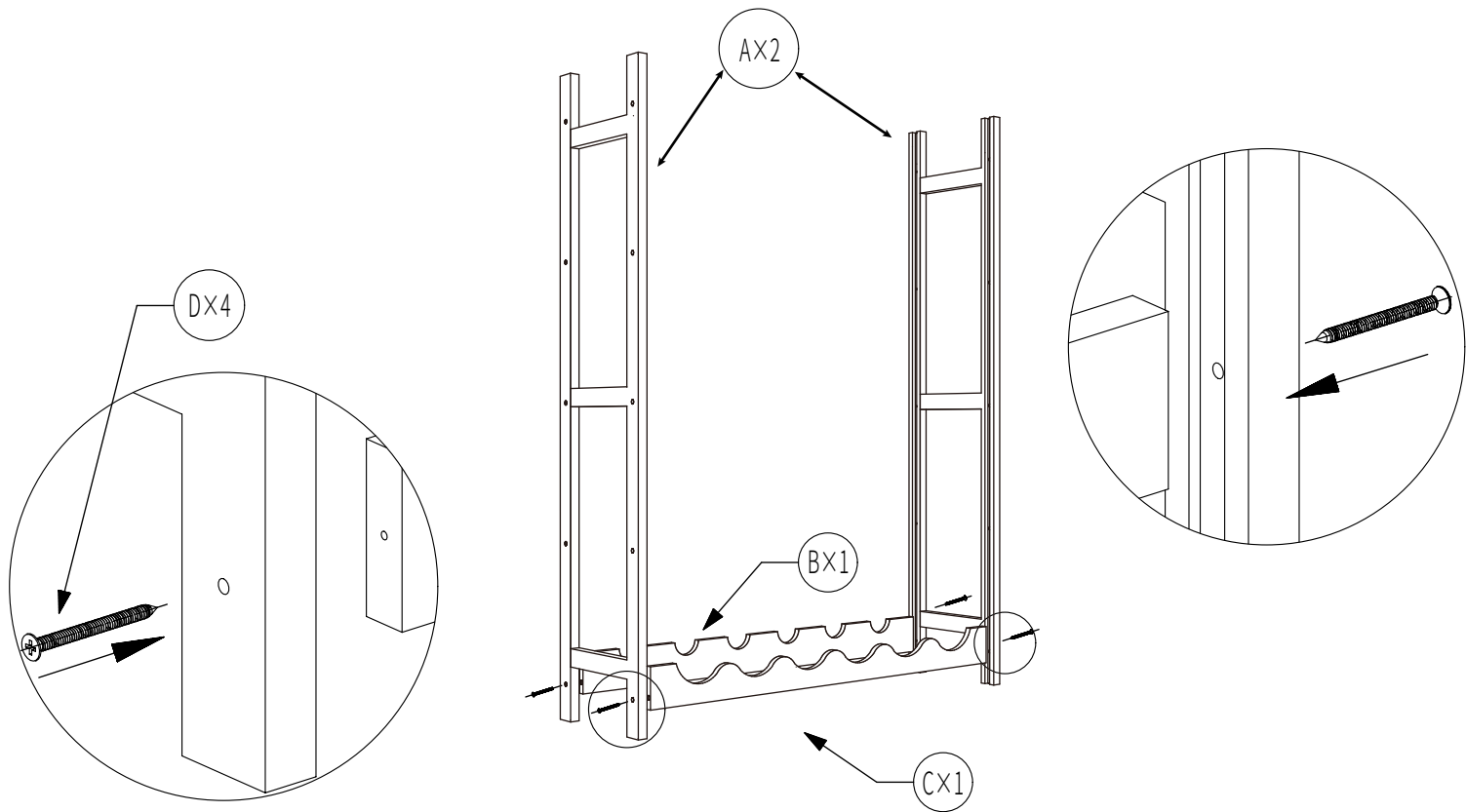

1

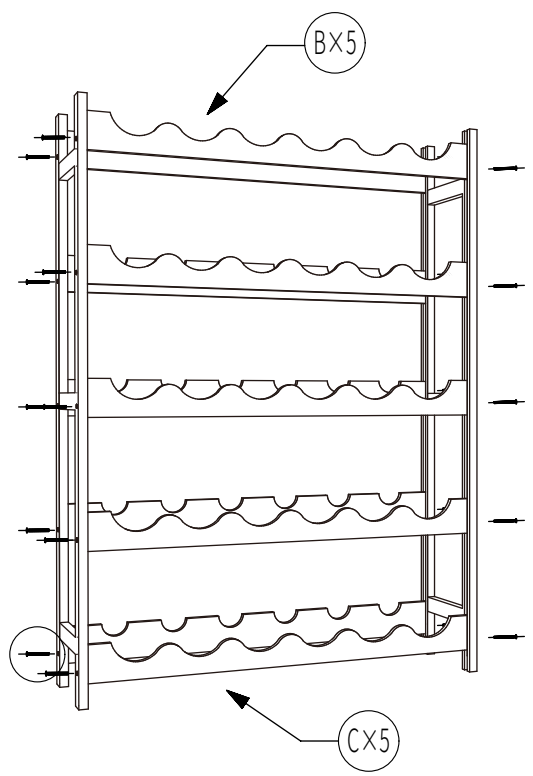

2

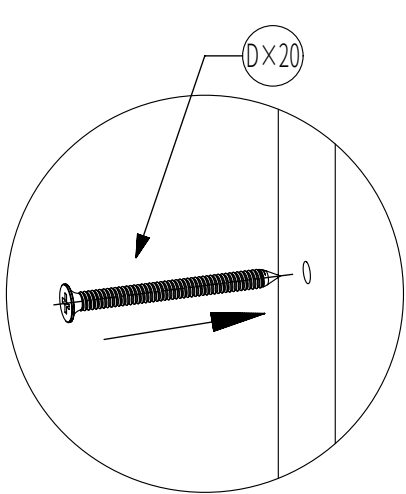

3

